

THE FLAG CODE

1. The National Flag alone shall be displayed in all public buildings, official residences, public squares, and institutions of learning every day throughout the year, and shall be raised at sunrise and lowered at sun down. It should be on the mast at the break of day, should remain flying throughout the day but shall not stay flying after the sun has set, except when specially prescribed. The flagstaff must be straight; slightly and gently tapering at the end.
2. The Flag shall be permanently hoisted, day and night in front of the following; at Malacanang, the official residence of the President of the Philippines; the Congress of the Philippines building, the Batasang Pambansa building; Supreme Court building; at the Rizal monument in Luneta, Manila; Aguinaldo Shrine in Kawit, Cavite; Barasoain Shrine in Malolos, Bulacan; the Tomb of the Unknown Soldier, Libingan ng mga Bayani; Musoleo de los Beteranos dela Revolucioin; all International Ports of Entry and all other places as may be designated by the Institute.

The flag shall be properly illuminated at night.

3. The Flag should never be used to return the salute of any individual or organization. It should never be dipped by way of compliment or salute to or for any person, except when used for exchanging courtesy as an official act between states.
4. The Flag, it flown from the flagpole, should have its blue on top in time of peace and the red field on top in time of war; if in a hanging position, the blue field should be to the right (left of the observer) in time of peace, and the red field to the right (left of the observer)in time of war.
5. In hoisting the Flag, it should be raised briskly to the top-end of the flagpole which, if planted on the ground, should be at a prominent place and higher than the roof of the principal building in the compound, or of such height as would give the flag a commanding position within the compound. If the pole is attached to a building, it should be on top of its roof, and if placed at a window, it must project to an angle pointing upward.
6. When the National Flag is used together with that of the Armed Forces or civic organization or with that of another nation, it must always be above or on the right of the other flag. When the National Flag is displayed in a parade with those of foreign nation, it shall always be in front of the center of the line of the other flags.
7. When the Flag is passing in a parade or in review, the people, if walking, should halt, uncover, stand at attention and salute; if sitting they should uncover, stand at attention and salute.
8. The flag shall be displayed on national holidays or special holidays as the President may proclaim not only in public buildings, official residence, public squares and institution or learning, but, whenever practicable, also in all private building and homes from sunrise to sunset.
9. The public display of foreign flag is prohibited except in foreign diplomatic establishments such as in chanceries, embassies, consulates, or other places

BTC-KLs/S16-HO-The Flag Code/page 2

authorized by bilateral or international agreement, or in international conferences of which the Philippines is a member, or on national holidays the foreign flag shall be displayed together with the National Flag, which shall occupy the place of honor, i.e., on the right of the foreign flag, and shall not be smaller than the foreign flag.

10. The Philippine National Flag shall not be hoisted or displayed in front of buildings owned or occupied by the alien individuals or corporations except on our national and special holidays or on their national holidays, subject, in the latter case, to the provisions of the next preceding paragraph.
11. When lowering the Flag, no part thereof should touch the ground. It should be handled and folded reverently. While the Flag is being raised or lowered and while the National Anthem is being played, the people should face the flag; uncover, stand at attention and salute. Moving vehicles should stop, and the passengers should alight, uncover, stand at attention and salute.
12. The Flag may be hoisted at half-mast as a sign of mourning. To display the Flag at half-mast, it must first be hoisted to full-mast allowing it to fly there for a moment before bringing it to the half-mast. From this position it may be raised but not lowered.

To lower the flag at sunset or at any other time when ordered, it must again be hoisted to full-mast before bringing it down. The flag may be hoisted at half-mast by authority of the President – in case of national mourning or on such other occasion as he may designate, or at the discretion of Department Heads or chief of local official in accordance with the regulation prescribed in Executive Order No.166 dated October 8, 1938, as amended.

13. The Flag shall never be festooned, shall always hang with nothing to cover its surface. It shall always occupy the highest place of honor and shall not be placed under any picture, or below a person.
14. The Flag shall never be used as a staff or whip, or covering for tables, or curtain for door ways. However, the Flag may be used by the Armed Forces to cover the casket of their honored dead, which include civilians who had rendered services in the Army, Navy, or civil office of great responsibility. The white triangle of the sun and stars will cover the head end of the casket, the blue stripe to the right, the red to the left of the deceased, with both colors evenly divided on each side of the casket. The Flag should never be lowered to the grave or allowed to touch the ground, except as authorized under Republic Act No. 3934. Wreaths of flowers should not be placed on top of a flag-shrouded casket. A cross may be placed over the flag as a symbol of "God above Country."
15. No imprint shall be made on the flag nor shall it be marred by advertisement, or in any manner desecrated. It shall not be worn as a whole or a part of a costume. It shall not be used as a pennant in the hood or in any part of a motor vehicle except in celebration of any national or special holiday as the President may designate.
16. It is inappropriate to use the Flag in a dancing pavilion or any place where hilarity is prevailing. Its used inside or outside a cockpit, club or other places where gambling or other vices are held is prohibited.

17. The National Flag shall never be used as a covering for a statue or monument nor should it be used to unveil the same.
18. A National Flag worn out through wear and tear should not be thrown on a garbage heap or used as a rag. It should be reverently burned to avoid misuse or desecration thereof. Government offices and educational institutions must not display worn-out or tattered flags. They should replace the same immediately.

KAB SCOUT KNOTS



Overhand Knot



Square Knot



Figure of 8 Knot

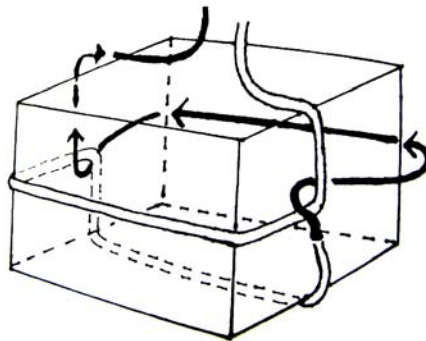

Packer's Knot

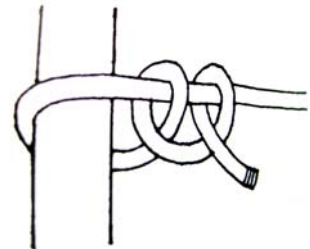

Two - half Hitches

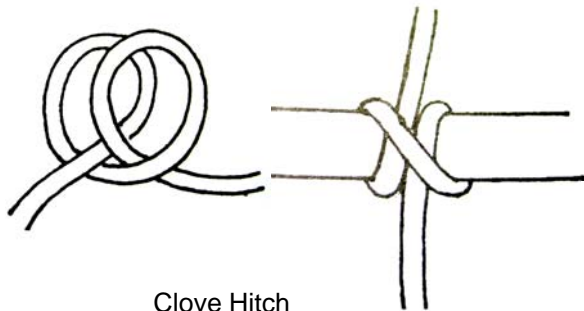

Clove Hitch

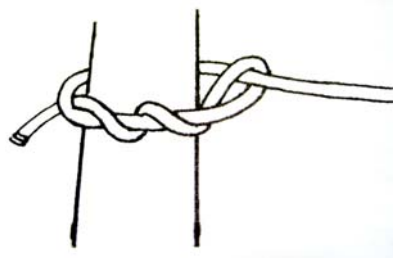

Timber Hitch

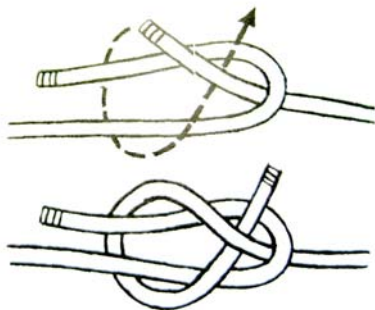

Sheep Bend

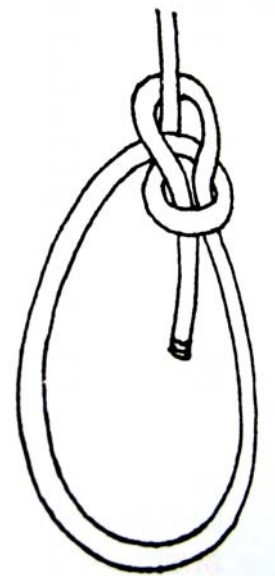

Bowline

EVOLUTION OF THE FLAG



Katipunan 1



Katipunan 2



Katipunan 3



Magdiwang



Magdalo



Sun of Liberty



Llanera



Katipunan 1

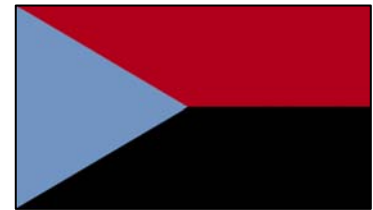

Tri-color



Philippine Flag